

Adam, Rouilly

SERVING MEDICAL EDUCATION WORLDWIDE

AR251/AR251-B INJECTION, VENEPUNCTURE, CANNULATION & INFUSION ARM

Instruction Manual

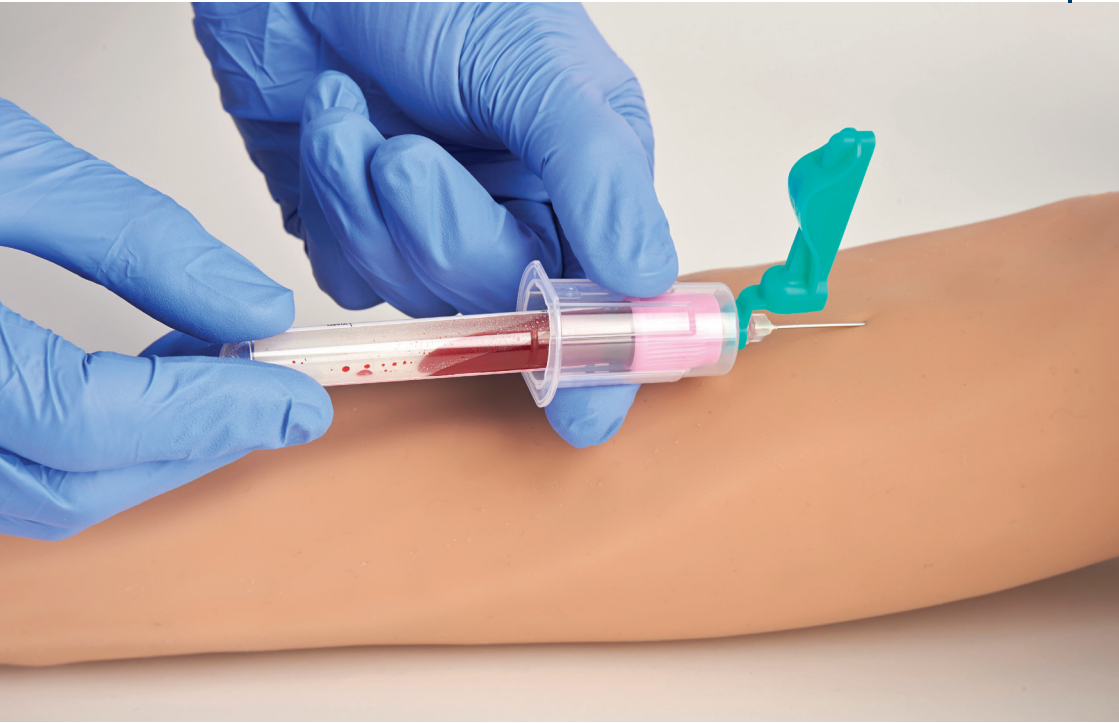

Thank you for purchasing this AR251 Venepuncture and Infusion Arm.

Cast from life, it shows a well developed male left arm in fine detail. The arm features a flexible wrist for added realism, durable silicone skin and is simple to set up, operate and maintain.

Please read this instruction manual carefully and retain it for future reference.

Skills

- Intravenous cannulation - on the back of the hand or forearm
- Setting up and monitoring infusions including application of dressings to secure cannula in place
- Withdrawal of blood using syringe or vacutainer

Features

- Easy to set up
- Flexible wrist for improved realism
- Closed blood system which is clean to use
- The skin is moulded from a specially selected grade of silicone for improved feel, durability and palpation of the veins
- Many procedures can be carried out before a replacement skin is required
- A realistic sensation is felt when the skin and vein are penetrated
- When charged with artificial blood, a realistic 'flashback' confirms correct needle location in the vein and blood can then be withdrawn
- Continuous vein system, and innovative two bottle sealed blood assembly, greatly reduce the risk of leakage
- The working veins, which can be identified from the 'blind veins' by palpation, are made from a material with self sealing characteristics that can be penetrated many times
- The self-sealing material used for the veins, as well as the silicone skin, enhance durability
- Automatic pressure relief valve
- Replacement skins and veins are simple to fit

Accessible Veins

- Dorsal metacarpal
- Cephalic
- Median cubital
- Basilic

Safety and Precautions



The veins in this arm contain natural latex which may cause an allergic reaction to some individuals. If a reaction occurs, discontinue use immediately and seek medical advice.



Do not leave the blood system pressurised when not in use.



Do not mark the skin with ink from ball point pens, marking pens or newsprint as these cannot be removed.



It is recommended that 21 gauge or smaller cannulae and needles be used for practice on the arm to avoid accelerated wear of the skin and veins.



Equipment used with all our training models should be selected according to local policy guidelines.



Please treat the Infusion Arm with the same care you would a patient.

Contents

Parts	4
- Supplied With	5
Before Use	
- Making the Blood Concentrate	7
- Setting Up the Arm Rest and Connecting the Veins to the Bottles	7
- Pressurising the Blood System	7
During Use	
- Using Vascular Access Devices and Keeping the System Pressurised	9
- When Blood Has Passed from One Bottle to the Other	9
After Use	
- Empty the Vein System of Blood	11
- Disconnect the Veins from the Bottles	11
- Using the Blanking Plugs for Transportation	11
- Flushing the Vein System and Bottles	13
- Cleaning the Skin and Removing Adhesive Residues	13
Replacing the Skin and Veins	
- 1. Remove the Old Skin and Vein System	15
- 2. Insert the New Vein System	17
- 3. Installing the New Arm Skin	19

Parts

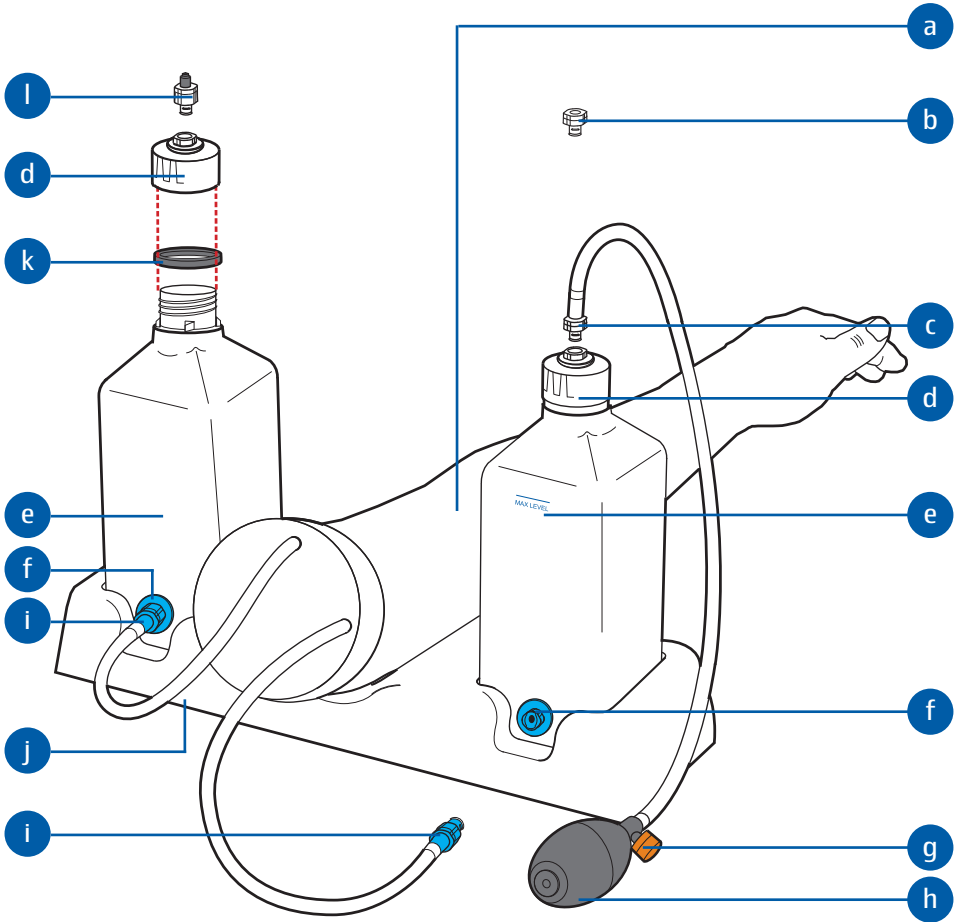

SCAN ME

- a Infusion Arm (made up of Skin, Vein, Core)
- b **S251/8 BLANKING PLUGS (x 2)**
- c **S251/11 TUBE AND BULB CONNECTOR**
- d White bottle cap (x 2)
- e **S251/4C BOTTLE (x 2)**
- f Blue bottle valve (x 2)
- g **S341/7 ORANGE PRESSURE RELEASE CAP**
- h **S341/6 BULB**
- i **S251/6 BLUE VEIN CONNECTOR (x 2)**
- j **S201/2A ARM REST**
- k **S251/4D RUBBER WASHER (X 2)**
- l **S251/7 PRESSURE RELEASE VALVE ASSEMBLY**

Supplied With

AR204 BLOOD CONCENTRATE

S251/3 CARRYING BAG



If you require replacement parts please contact our Sales Department, quoting codes where applicable.



Scan the QR code to access the product video.
<https://youtu.be/Y9wr5EP300o>

Before Use

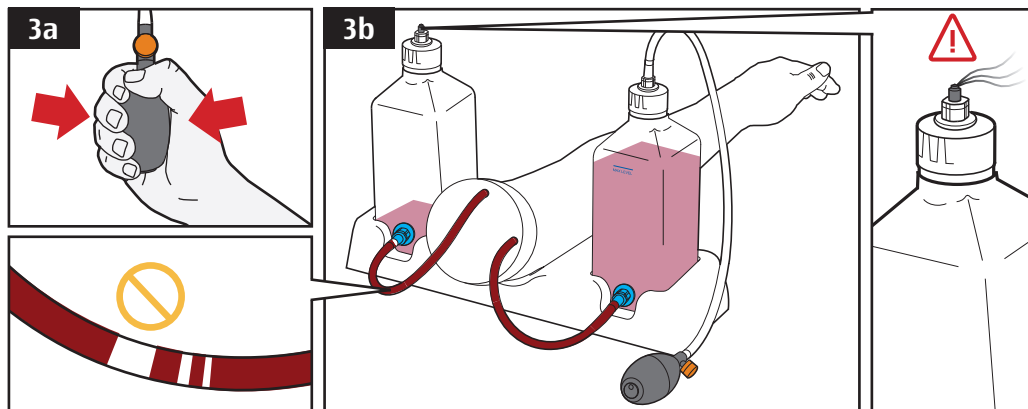
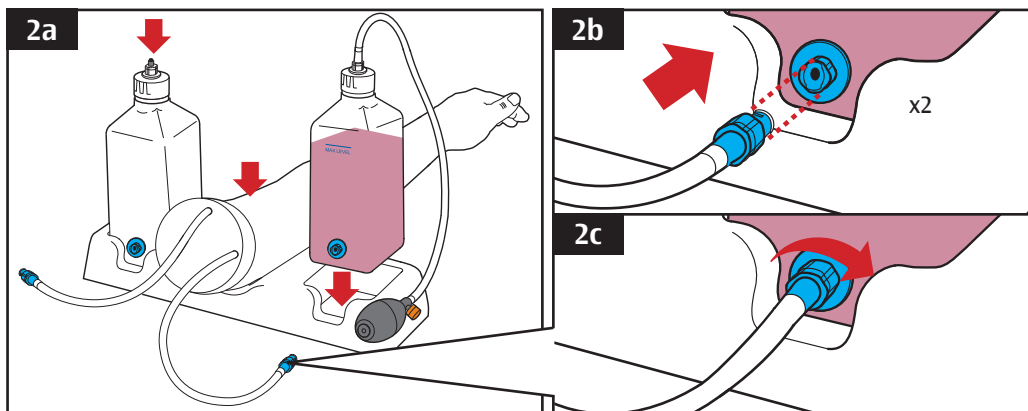
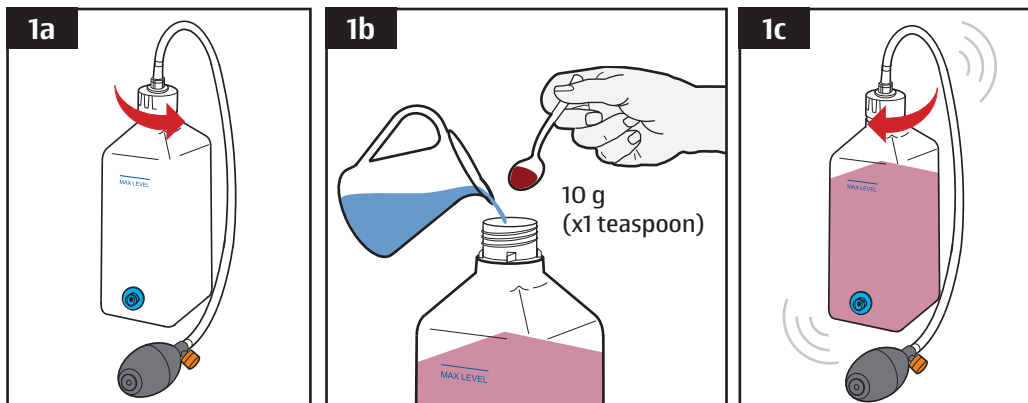

Making the Blood Concentrate

Ensure the work area is clean and dry.

Keep paper towels nearby in case of any spillage.

1a

Unscrew the cap of the bottle with the tube and bulb attached.

1b

Prepare artificial blood by putting 10 grams (Approx. 1 teaspoon) of artificial blood powder concentrate in the bottle and fill with water to the “Max Level” line.

1c

Replace cap and shake well to mix.

Setting Up the Arm Rest and Connecting the Veins to the Bottles

2a

Locate the bottles in the arm rest holder positioning the blue connectors to the slots in the back.

Place the arm with the palm of the hand facing down, supporting the arm at the shoulder end on the arm rest.

2b

Connect the arm veins to both bottles using the blue connectors. Locate the connector and insert fully into the valve.

2c

Twist the connector clockwise until it locks into place.

Pressurising the Blood System

3a

Pump the bulb to charge the vein system.

3b

Continue to pump the bulb until blood begins to flow through the arm and into the other bottle.



There should be no visible air bubbles in the veins before use. If bubbles are present, keep charging the system until there is a steady flow of blood.



Do not over pressurise the system. The pressure release valve on the second bottle will automatically open if the system is over pressurised.

During Use

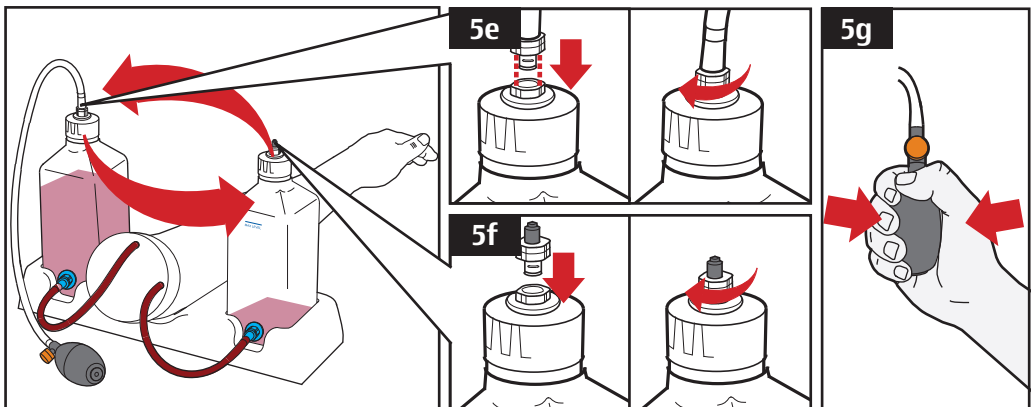
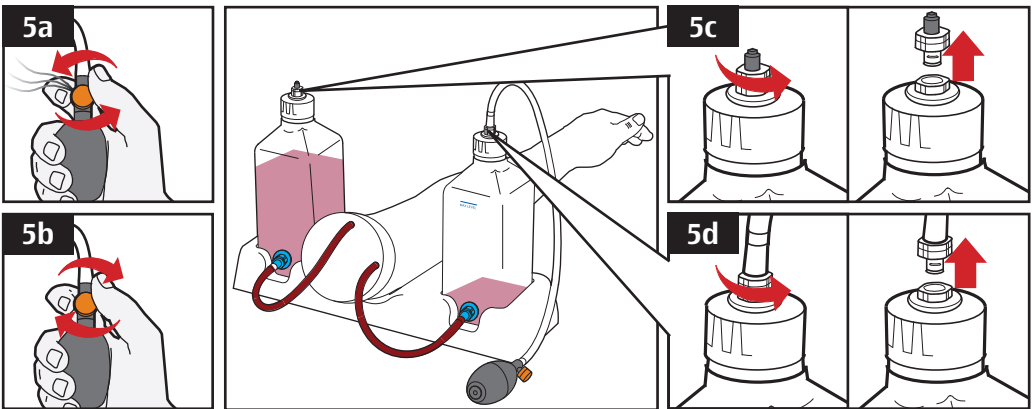
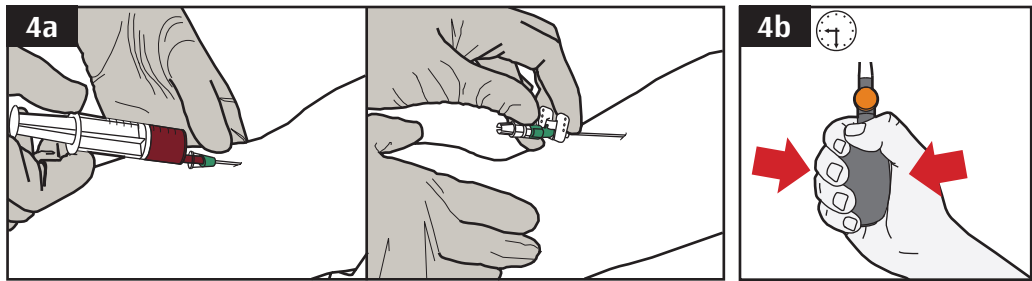

Using Vascular Access Devices and Keeping the System Pressurised

4a

A range of vascular access devices may be used to take blood from the arm such as syringes, vacutainers and cannulae.

4b

Periodically pump the bulb to maintain pressure in the system during use.



It is recommended that 21 gauge or smaller cannulae and needles be used on the arm to avoid accelerated wear of the skin and veins.

When Blood Has Passed from One Bottle to the Other

During use, blood will eventually pass from one bottle to the other.

The bulb can easily be swapped to the other bottle so use may continue relatively uninterrupted.

Before the first bottle is completely empty and air enters the vein system, discontinue use and depressurise.

5a

To depressurise the system, open the orange cap on the bulb and allow air to escape.

5b

Once the system has depressurised, close the orange cap again.

5c

Remove the pressure release valve from the second bottle by turning it anti-clockwise and pulling it out of the bottle valve.

5d

Remove the bulb and tube from the first bottle by turning the connector anti-clockwise and pulling it out of the bottle valve.

5e

Swap both the bulb and pressure release valve onto the alternate bottles. Locate the tube and bulb connector fully into the second bottle valve and turn clockwise until it locks into place.

5f

Locate the pressure release valve fully into the first bottle valve and turn clockwise until it locks into place.

5g

Re-charge the system by pumping the bulb until blood begins to flow into the first bottle.

The arm is now ready for use again.

After Use

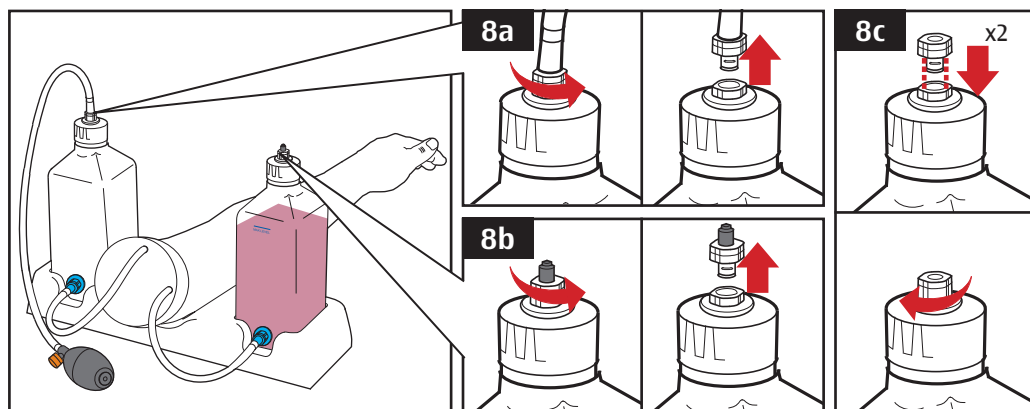
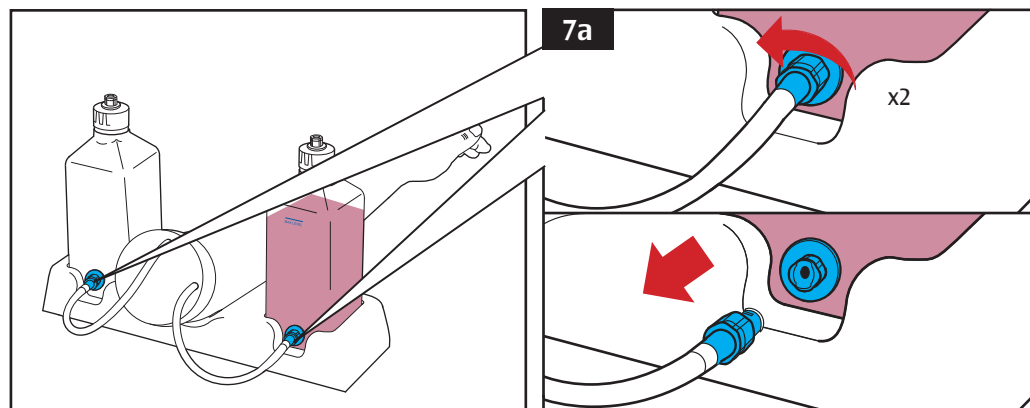
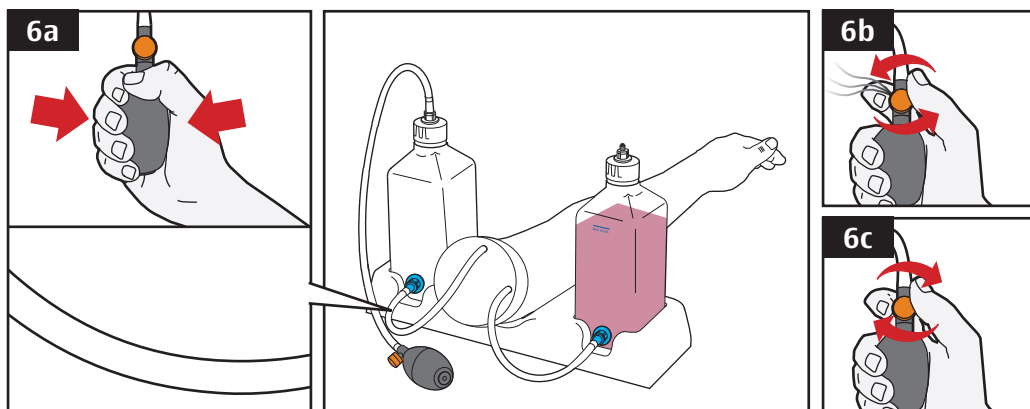

Empty the Vein System of Blood

6a

After use, pump the bulb until blood has collected in one bottle and the vein system is empty.

6b

Locate the pressure release valve fully into the first bottle valve and turn clockwise until it locks into place.

6c

Once the system has depressurised, close the orange cap.

Disconnect the Veins from the Bottles

7a

Disconnect **both veins** from **both bottles** before transportation or storage.

To disconnect, turn the blue connectors anti-clockwise and pull out of the bottle valves.



When not in use, the bottles should be completely emptied of blood and washed out.

Using the Blanking Plugs for Transportation

The supplied blanking plugs may be placed into both bottles for easy transportation.

8a

Remove the bulb and tube from the bottle by turning the connector anti-clockwise and pulling it out of the white bottle valve.

8b

Remove the pressure release valve from the bottle by turning it anti-clockwise and pulling out of the bottle valve.

8c

Insert blanking plugs into both bottles by locating plugs fully into bottle valves and turning clockwise until they lock into place.



When not in use, the bottles should be completely emptied of blood and washed out.

After Use

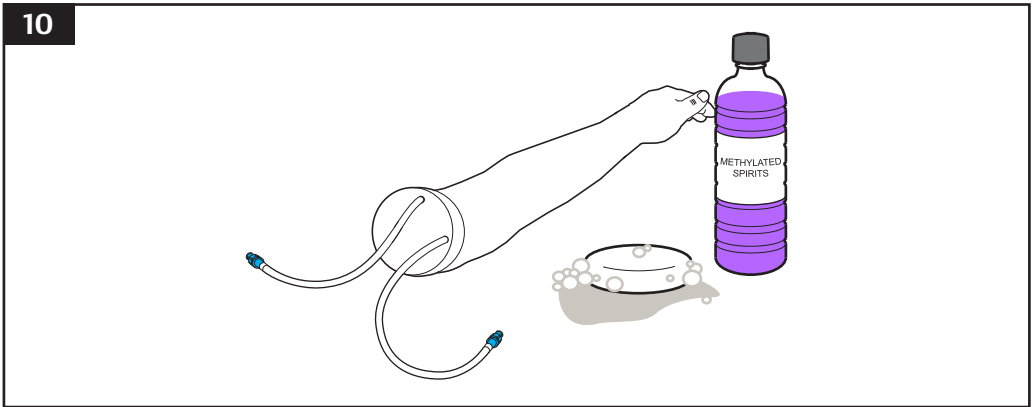
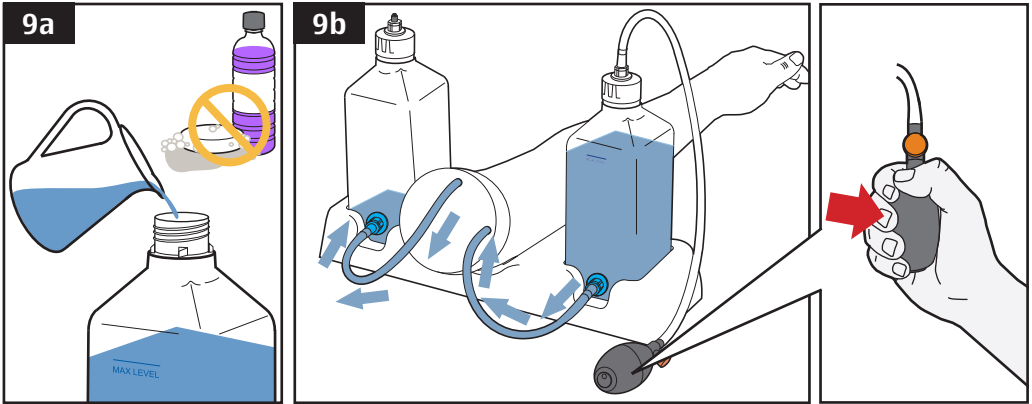

Storage and Transportation



Flushing the Vein System and Bottles



Before storage, or at the end of a training session, the vein system must be flushed through with clean water to prevent mould growth.



Do not use soap, detergents or any other chemical cleaners to clean the vein system or bottles.

9a

To clean the bottles and veins the system should be flushed with **warm water**.
Fill the first bottle with warm water and attach the bulb and tube.

9b

Set up the infusion arm as before, connecting both veins to both bottles in the stand.

Pump the bulb to begin flushing the system. Allow all of the water to flush through the system and pass into the second bottle. Maintain system pressure by pumping the bulb.

Depressurise the system and empty the bottles. Allow the system to dry fully.

Cleaning the Skin and Removing Adhesive Residues

10

The arm skin may be washed with a soap solution.

Methylated spirits can be used to remove **residues** from **adhesive tapes** and **dressings** etc.



Do not mark the skin with ink from ball point pens, marking pens or newsprint as these cannot be removed.

Using the Supplied Carrying Bag

18

After use and before storage the cleaned and dried arm, bottles and stand should be placed in the supplied **Carrying Bag**.



Do not store or transport the arm with blood inside.
Do not store the arm near heat or where it may experience extremes in temperature and humidity.

Replacing the Skin and Veins

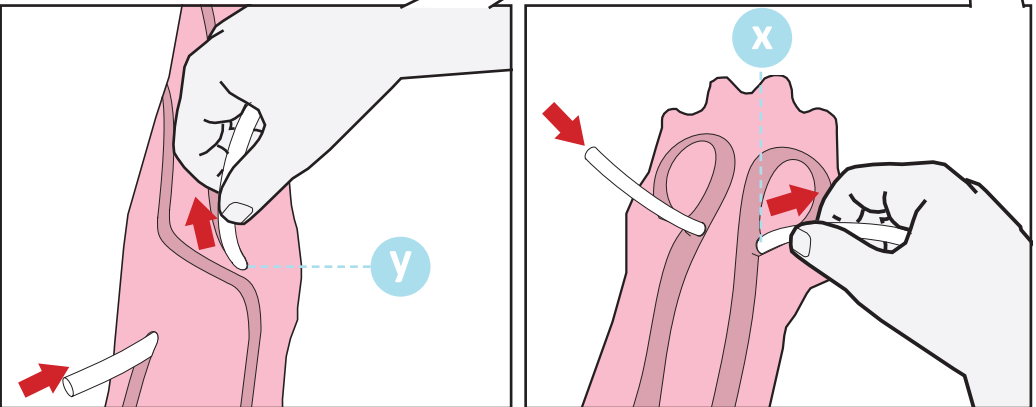
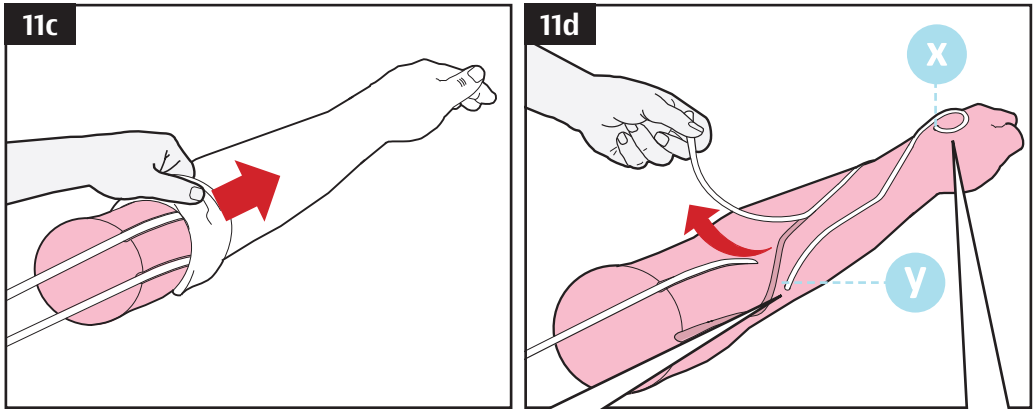
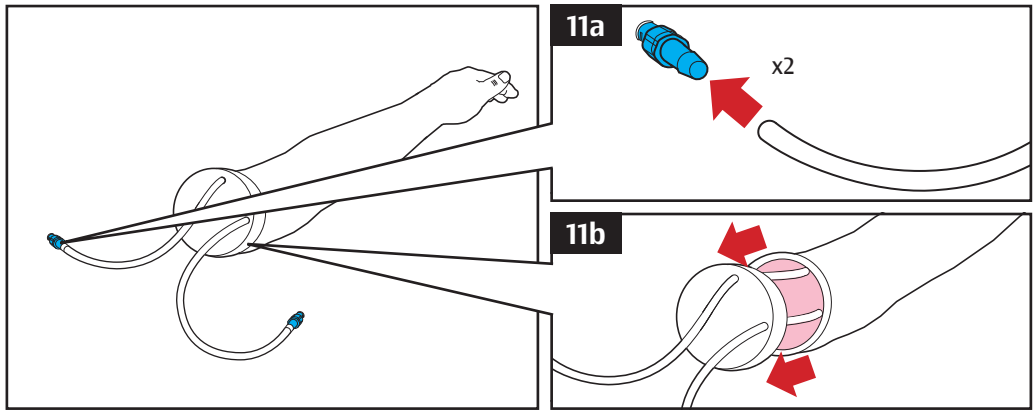

Replacement Skin and Vein Sets

Replacement skin and vein sets are available from **Adam,Rouilly** or your **local distributor**:

AR253 SKIN AND VEIN SET, WHITE for AR251

AR253-B SKIN AND VEIN SET, BLACK for AR251-B



The veins in this arm contain natural latex which may cause an allergic reaction to some individuals. If a reaction occurs, discontinue use immediately and seek medical advice.



Replacing the skin and vein set is a relatively simple procedure, as below. However we can carry out this service for you. Please contact our Sales Department for more information.

1. Remove the Old Skin and Vein System

11a

Remove the two blue vein connectors from each arm vein.
Keep these safely for re-fitting onto the new vein set later.

11b

Detach the white end cap from the shoulder of the arm and pull off from the two veins completely.

11c

Pull the old arm skin off the inner arm core and throw away.

11d

Remove the old vein system from the core by carefully removing it from the channels in the arm core.

Be sure to remove the veins **carefully** from tunnels **x** and **y** so that the core is not damaged.



Excessive force during vein removal may cause damage to the core.

Continues, please see next page...

Replacing the Skin and Veins (Continued)

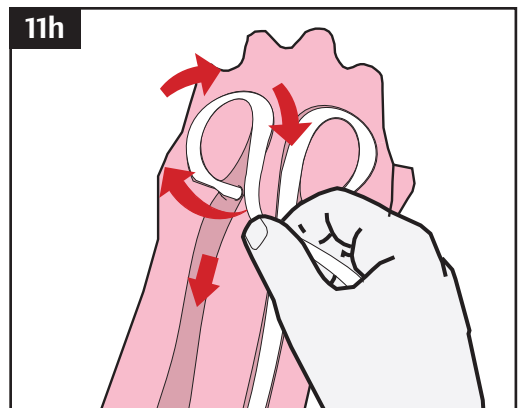
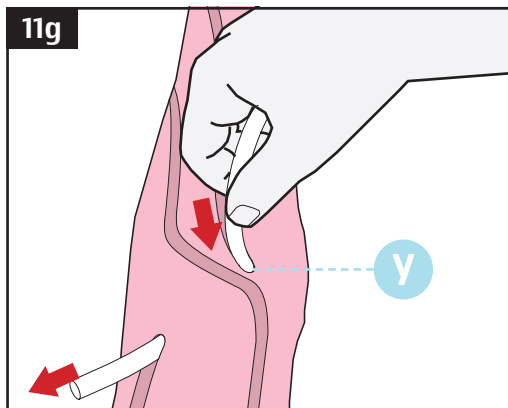
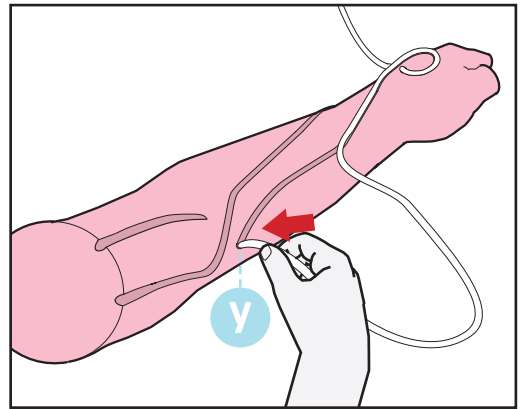
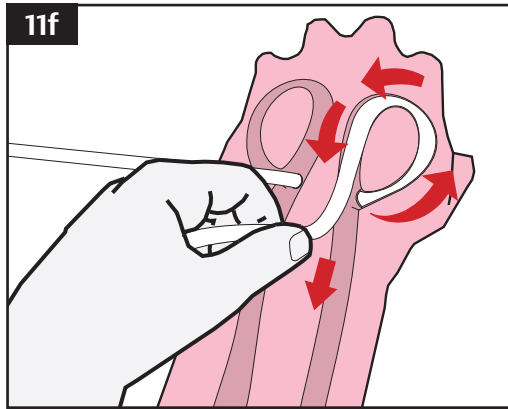
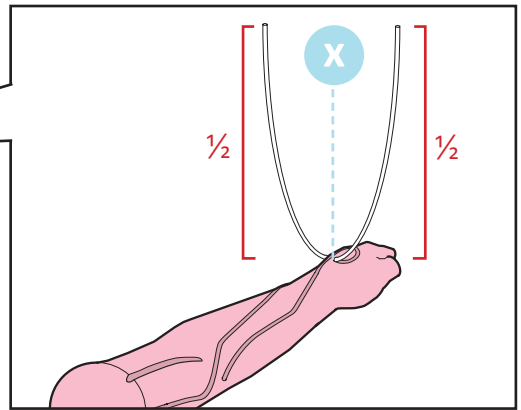
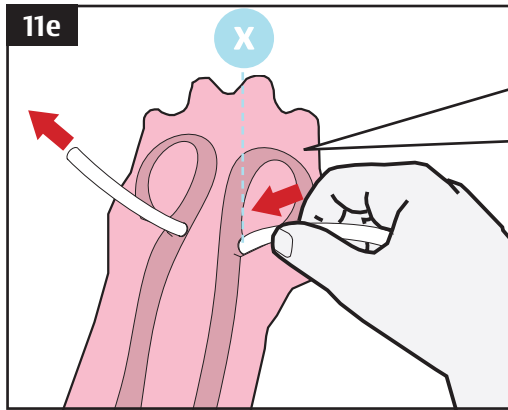

2. Insert the New Vein System

11e

To insert the new vein, first loop it through tunnel **x** in the back of the hand. Pull the vein through so that there are equal halves on each side of the tunnel.

11f

With the back of the core facing you, loop the first half vein around the right channel in the back of the hand and down the arm to tunnel **y**

11g

Insert the vein through tunnel **y**

11h

Loop the other half of the vein around the left channel in the back of the hand.

Continues, please see next page...

Replacing the Skin and Veins (Continued)

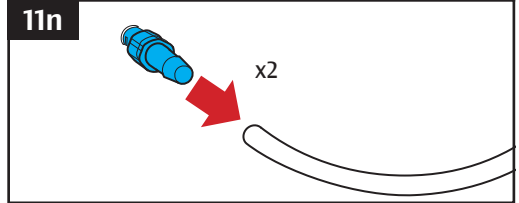
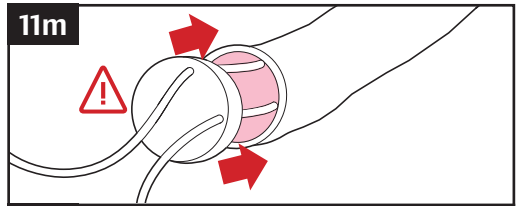
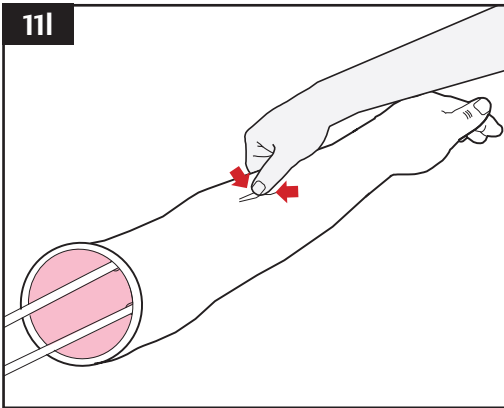
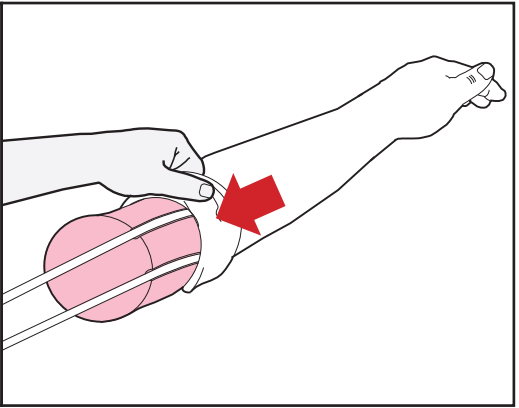
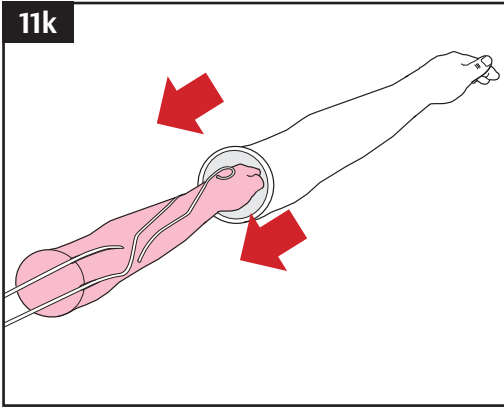
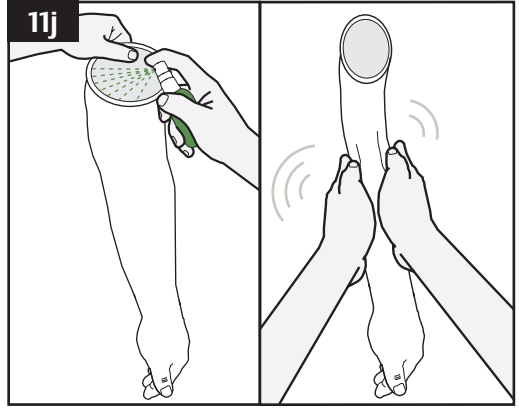
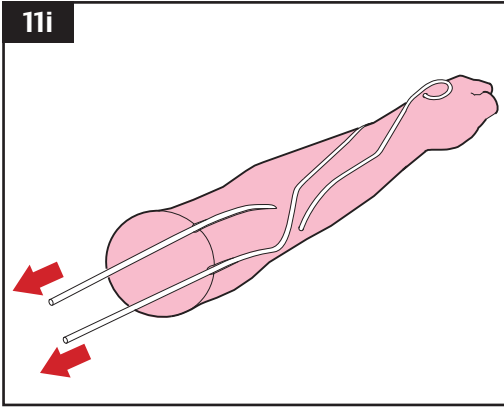

2. Insert the New Vein System (Continued)

11i

Insert the rest of the vein system into its corresponding channels in the arm core, keeping the two ends of remaining vein out of the way during installation of the new arm skin.

3. Installing the New Arm Skin

11j

Apply the lubricant (as supplied in the **AR253/AR253-B** kit) liberally down the inside of the new skin and work it down by rubbing sides together.



Please observe the warnings on the lubricant label.

11k

With the end of the arm core facing you, slide the arm core over the hand end of the core, all the way to the shoulder.

11l

Be sure that the new vein system is still in the vein channels in the arm core. If the vein is not in the channel in the core it can be pushed back into the channel through the skin.

11m

Replace the end cap by threading both ends of the vein through the two holes, pushing firmly into place



Ensure that the veins are kink free and pulled fully through the end cap.

11n

Replace both blue vein connectors in each end of the new vein system.

The arm is now ready for use again.

2 Year Guarantee



All products manufactured by Adam,Rouilly are covered by our full 2 Year Guarantee. This guarantee applies to models which have been used correctly and covers durability and functionality.

Adam,Rouilly

As part of our policy of continual product development, the specification of products may alter without prior notice.

Adam,Rouilly has over 100 year's experience in providing quality medical models and simulators.

Should you require any further information please contact our Sales Department who will be pleased to help with your enquiry.

Adam,Rouilly Limited
Castle Road
Eurolink Business Park
Sittingbourne
Kent
United Kingdom
ME10 3AG

T: +44(0)1795 471378
F: +44(0)1795 479787
E: sales@adam-rouilly.co.uk
www.adam-rouilly.co.uk